

3 WAY PALLET STACKER (VNA FORKLIFT)

High-level dense storage solution for VNA warehouse



BANYITONG SCIENCE & TECHNOLOGY DEVELOPING CO.,LTD.

Add: Crossing of Dai he Road and Cailun Road,Hefei,China

Tel: +86 551 6219 3112

Email: sales@mimachina.com

Website: www.mimaforklift.com



Website



Super High Storage Capacity Super Narrow Aisle

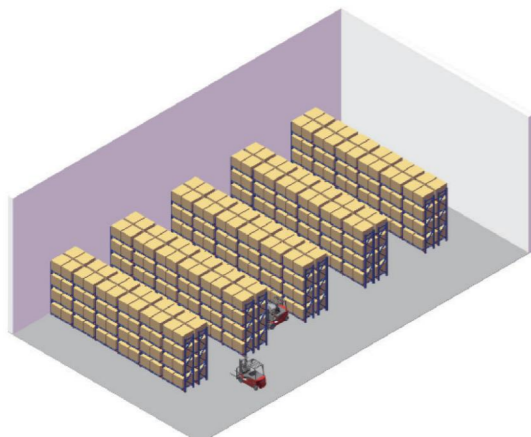

Electric counterbalance forklift

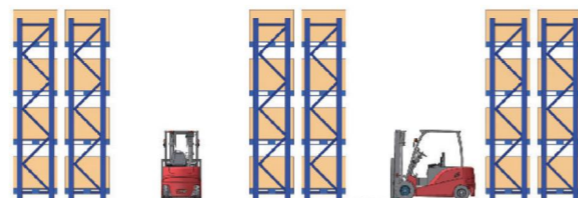

5 meters rack height

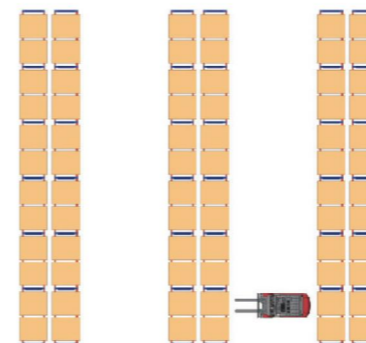

4 meters rack aisle width

- Electric counterbalance forklift
- Small qty pallets
- Wide stacking aisle (about 4 meters)
- Low rack height(about 5 meters)
- High unit pallet storage cost

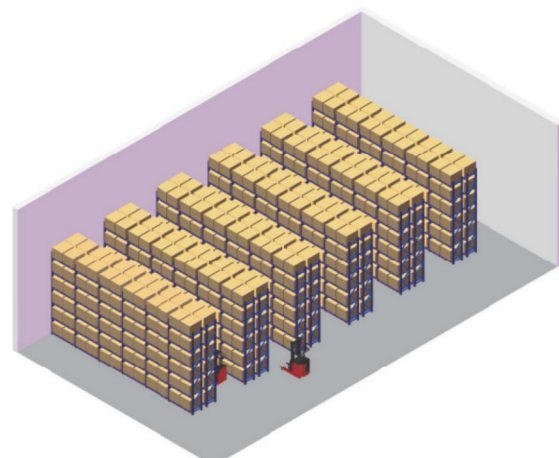

Electric reach truck



7.5 meters rack height

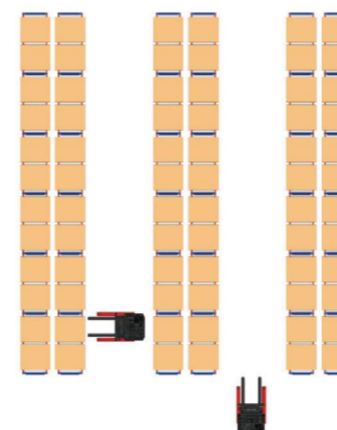

3 meters rack aisle width

- Electric reach truck
- Compared with electric counterbalance forklift
- Pallet qty increased by 80%
- Rack height increased by 40% (about 7.5meters)
- Stacking aisle width decreased by 25% (about 3 meters)
- In same warehouse area, unit pallet storage cost increased by 40%

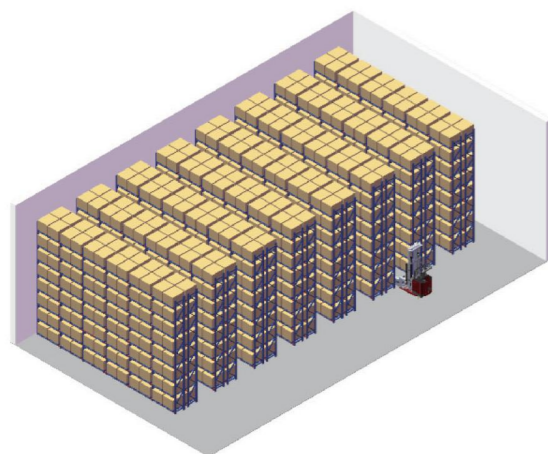

Electric 3-way pallet stacker

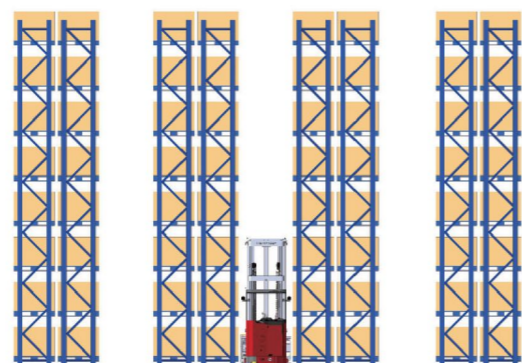

The height of the shelf is more than 10 meters, the highest can reach 14.2 meters

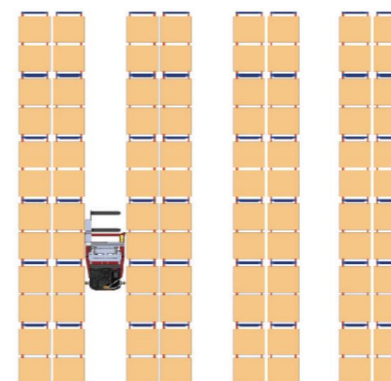

1.5 meters rack aisle width

- VNA 3 way pallet stacker
- Compared with electric counterbalance forklift
- Pallet qty increased by 200%
- Rack height increased by 100% (about 14.2meters)
- Stacking aisle width decreased by 55% (minimum 1.5 meters)
- In same warehouse area, unit pallet storage cost increased by 60%



* MC10 can fulfil it



MC10 Stand-on 3 Way Pallet Stacker

Rated Capacity: 1000kg
 Max.Lifting Height: 7500mm
 Min.Stacking Aisle: 1500mm
 Drive Type:Stand-on

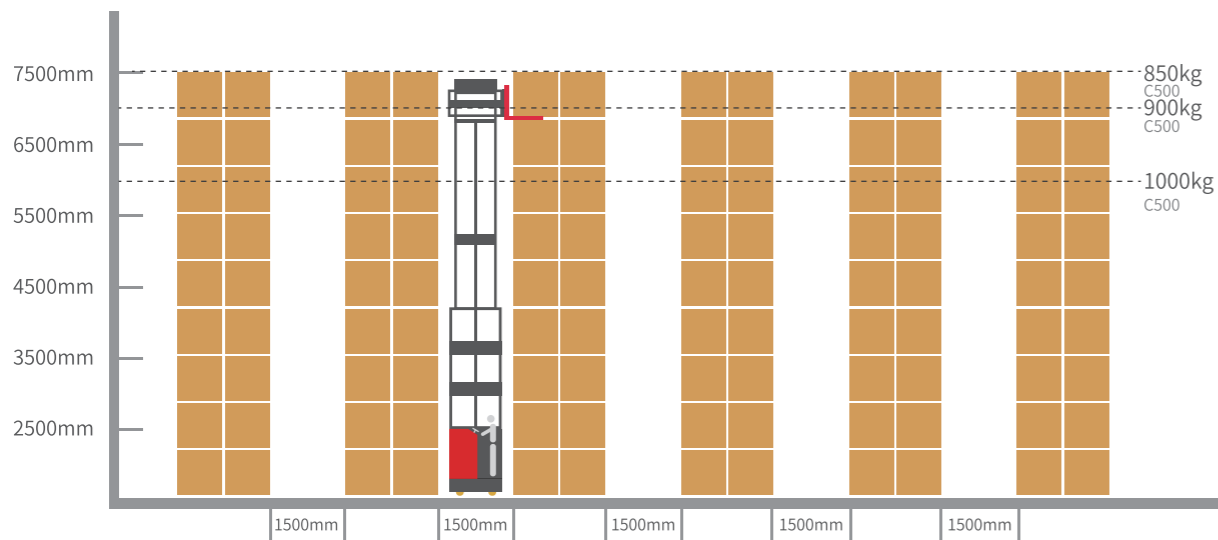

MC16 Stand-on 3 Way Pallet Stacker

Rated Capacity: 1600kg
 Max.Lifting Height: 10000mm
 Min.Stacking Aisle: 1600mm
 Drive Type:Stand-on

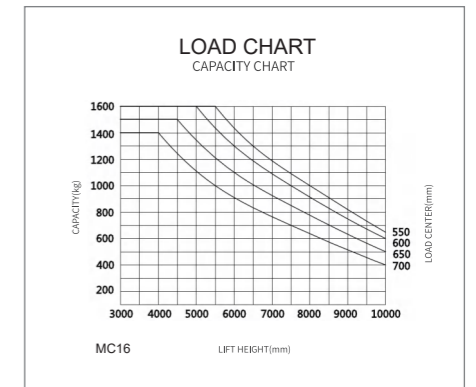
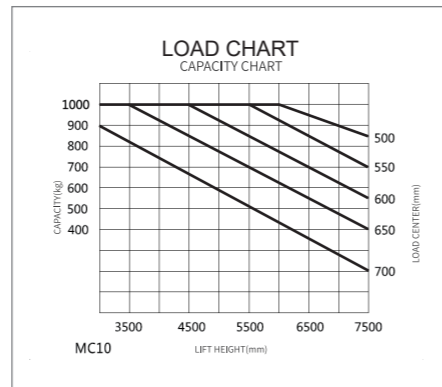
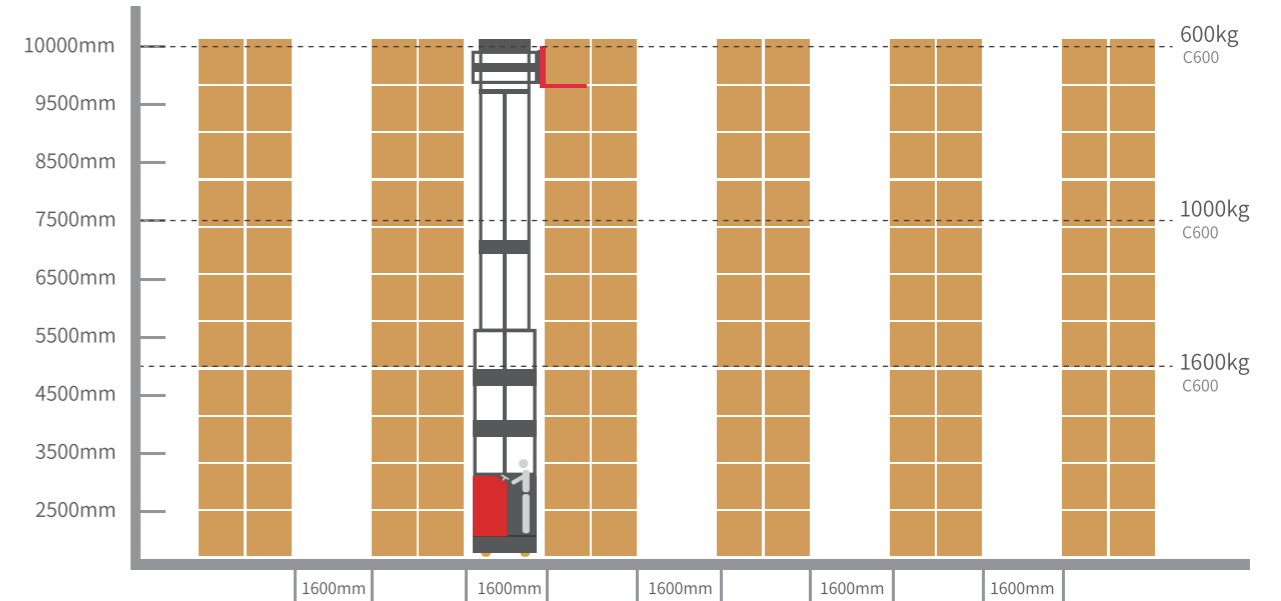



MCA16 Seated 3 Way Pallet Stacker

Rated Capacity: 1600kg
 Max.Lifting Height: 12000mm
 Min.Stacking Aisle: 1600mm
 Drive Type:Seated

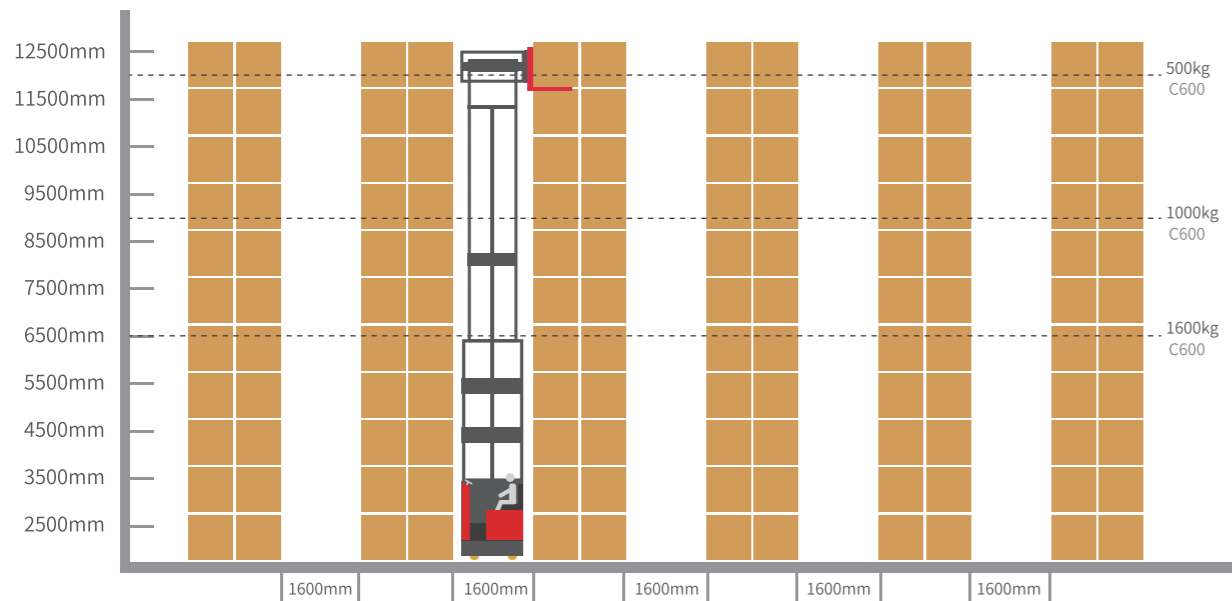

MCC16 Man Up Turret Truck

Rated Capacity: 1600kg
 Max.Lifting Height: 14200mm
 Min.Stacking Aisle: 1650mm
 Drive Type:Stand-on/Seated

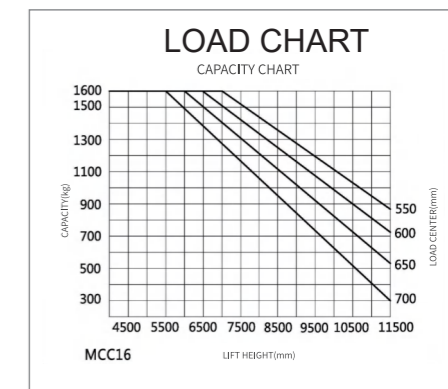
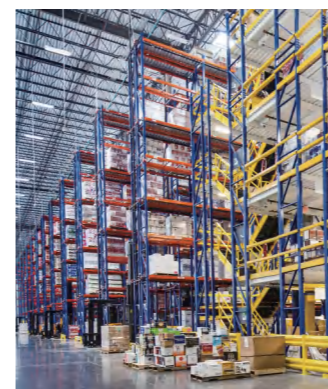
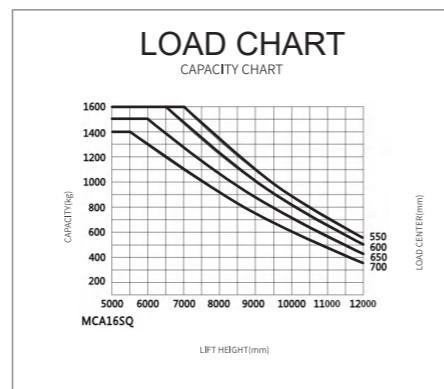
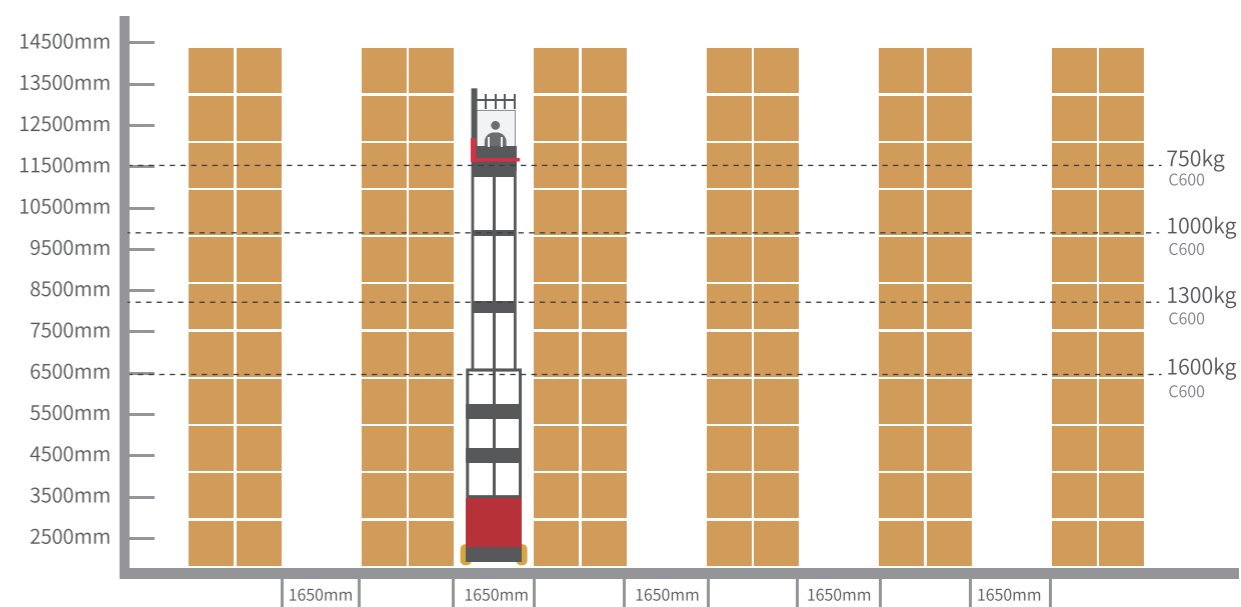

High Efficiency

Driving speed

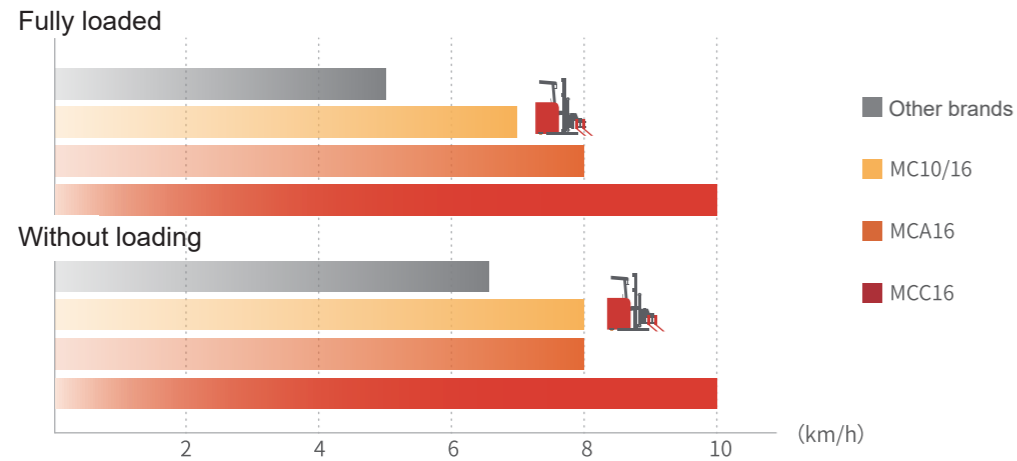

Lifting speed

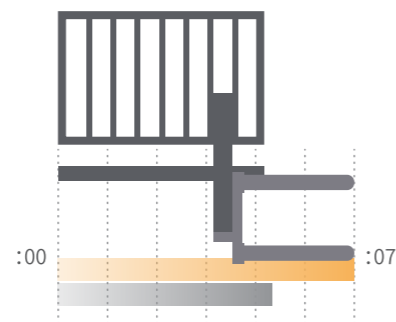
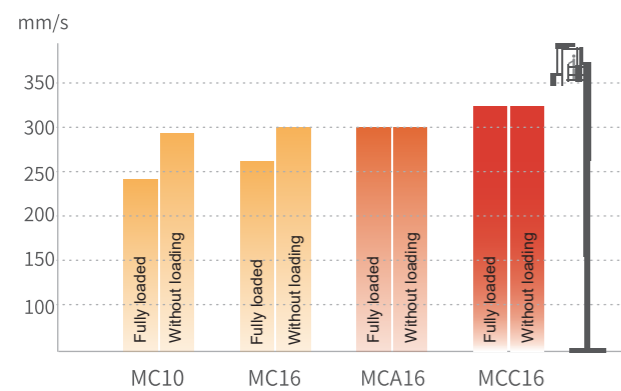

The fork can complete the side-shifting movement within 7 seconds

Lowering speed

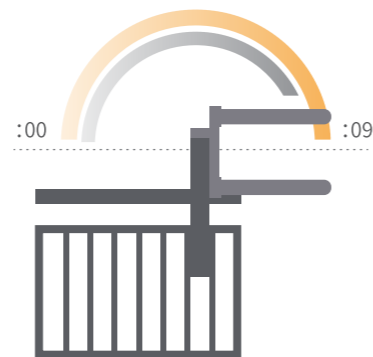
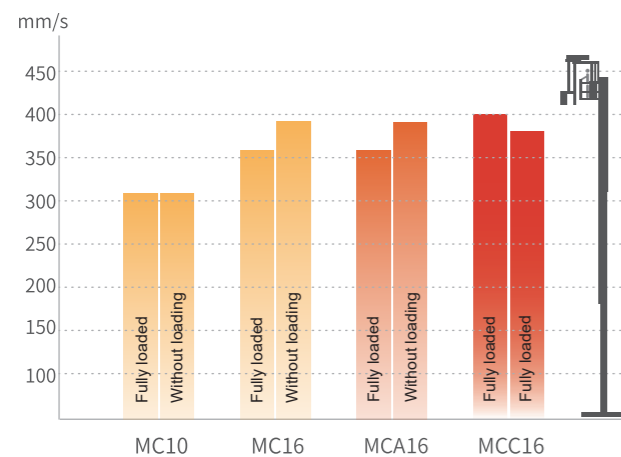

The fork can complete 180° rotating movement within 9 seconds

More Comfortable



MC10/16



Cabin



LCD display



Drive wheel indicator



Multi way valve

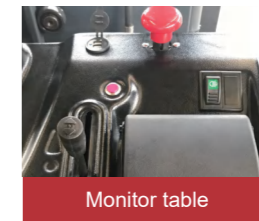

Monitor table

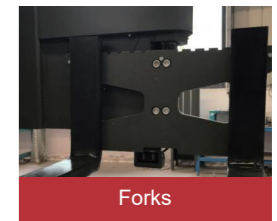

Forks



MCA16



Cabin



LCD display



Drive wheel indicator



Multi way valve



Steering wheel

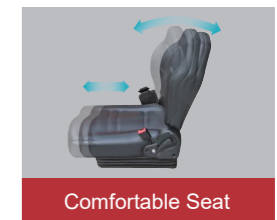

Comfortable Seat



MCC16



Cabin

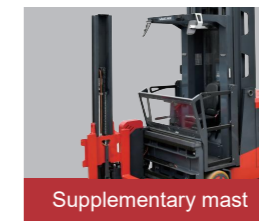

Supplementary mast



Central integrated console

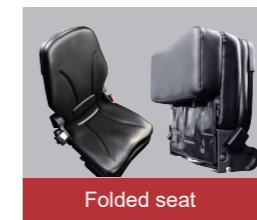

Folded seat



Big diameter load wheel

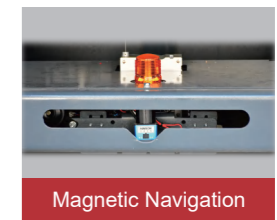

Magnetic Navigation



MiMA three-way pallet stacker series is designed for narrower aisles, higher lifting heights with fantastic visibility, helping improve warehouse utilization and simple goods handling processes. With a three-way stacker, you can maximize your space, simplify the process of cargo handling, stacking and picking, and improve working efficiency. The three-way stacker series adopts imported American Curtis controller, which has excellent performance, stability and reliability. A variety of driving modes and configurations to meet different working conditions and industry needs, providing more choices for your warehouse handling solutions.

Professional solutions to narrow aisle high-level storage

MAIN FUNCTION

01 / More Flexible and Efficient

The Fork can move left and right and rotate 180°

MiMA three-way pallet stacker series, the fork can move left and right and rotate 180°. When stacking in the working aisle, the vehicle does not need to turn, and the operation is simple and convenient. Fork-picking of goods is efficient and stable, and the operation is more convenient and flexible, greatly improving the utilization rate of the warehouse and the working efficiency.

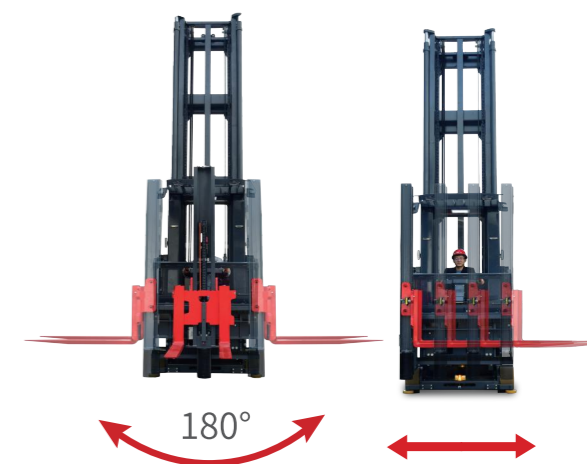

02 / Powerful and Durable

High voltage& low current Maintenance free, more comfortable

With high voltage, low current and low energy consumption, it can provide longer working hours. The core controller and other related components of the whole vehicle are imported products, which are stable and worry free. The drive, steering and lifting motors of the whole vehicle are all full AC motors without brushes, which are maintenance free and safe.

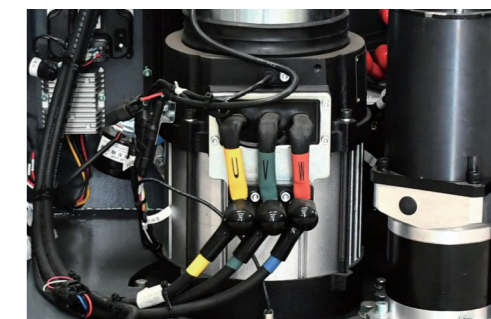

03 / Ultra-high Lifting High-precision Mast

High-strength mast structure makes strong load capacity at higher lift heights

Large section mast structure, adopting imported high-strength high rigidity H-shaped steel, which greatly reduces the mast deflection and deformation when stacking at high positions. The outer mast adopts a semi-closed rectangular frame structure and is equipped with a slant rod device, and is designed with ultra-high Strength. The inner mast adopts a central guide rail design, which is reprocessed by a horizontal gantry milling machine after integral welding to ensure high precision. The integral large cabin and the specially designed side shift carriage ensure the stability and reliability of the fork.



04 / Navigation mode

Mechanical guide rail mode

Beams are installed at the bottom of the racks, and guide rails are installed on the ground. The vehicle travels along the rails, driving more efficiently and safely.

- **Mechanical guide rail mode** (Seat and man-on-board model configuration)

No need to operate the steering wheel in the aisle, you can operate the lifting and walking functions simultaneously to improve the operation efficiency

- **Low rail guidance mode** (optional)

Rail height 50mm/40mm. Bottom goods can be placed directly on the floor without the need for additional beams.

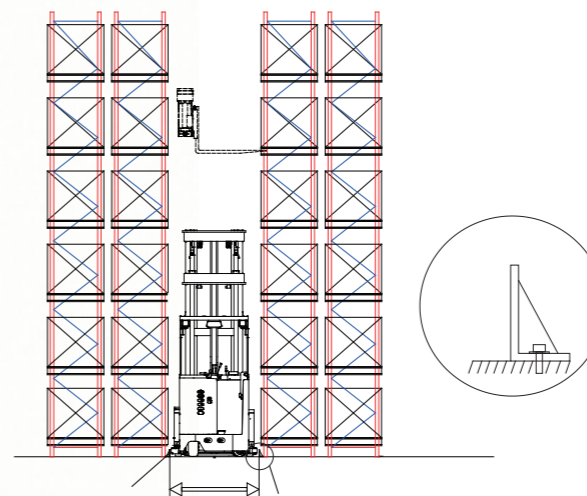

Mechanical rail

Magnetic or wire navigation modes*

Save the cost of the bottom beams of the racks, the goods can be placed directly on the ground. No need to install ground guide rails, avoid ground construction, and reduce warehouse construction costs!

Magnetic stripe navigation/Wire navigation

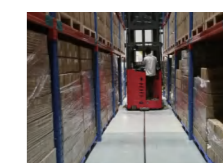
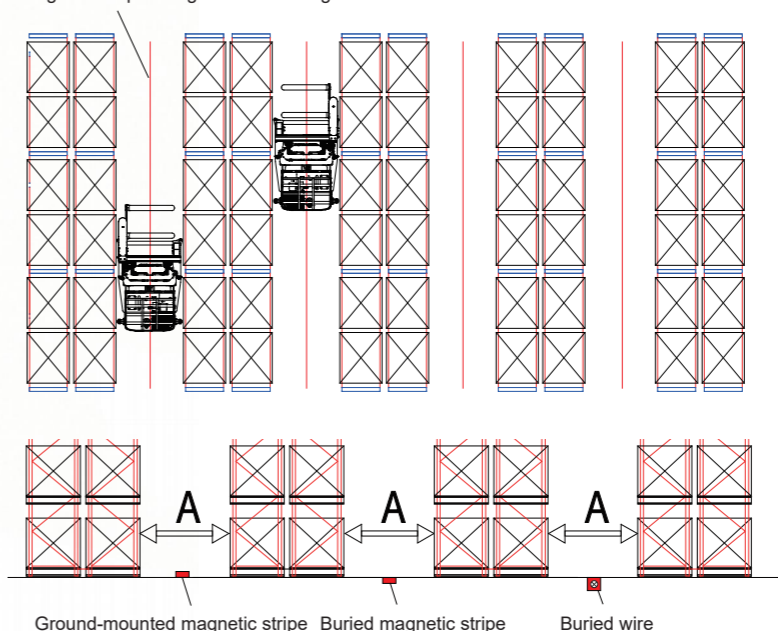

Ground-mounted magnetic stripe



Buried magnetic stripe



Buried wire

* please refer to the configuration table for some model options

05 / Highlights of differentiated configuration

(please refer to the configuration table for some model options)

■ Electric fork head*

Compared with traditional hydraulically driven fork head, electric fork head has the following advantages:

- 1.Reduce energy consumption, improve vehicle endurance.
- 2.Reduce system heating, improve vehicle reliability.
- 3.Motor driven fork head structure, no need to connect oil pipe, motor is maintenance free, no hydraulic oil and other media polluting the environment, more green.
- 4.Low noise motor, no noise pollution.
- 5.Electric fork head improves the controllability, stability and accuracy of the fork rotating and side shifting.
- 6.Reduce mast shaking when stacking goods, improve the performance of the whole vehicle.
- 7.The bridge of the electric fork head is designed to be narrower, increase the safety distance of the stacking aisle.

■ Low energy consumption

Compared with the hydraulic fork head, the energy consumption is reduced by about 80%, and the vehicle energy consumption is reduced by 20%

■ More stable

Improve fork stability and reduce shaking

■ Low noise

Adopting Low noise reduction motor

■ Pollution-free

No oil pipe is required, and the motor is maintenance free



■ Height pre-selection*

Through the setting of the height sensor and the optimization of the hydraulic and electrical system of the whole vehicle, the fork can be operated to the specified height with one key, which completely liberates the manual operation.

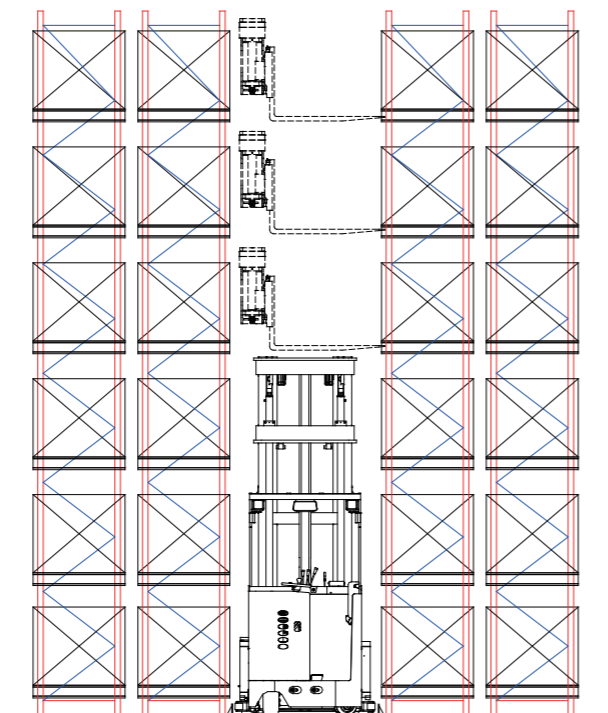
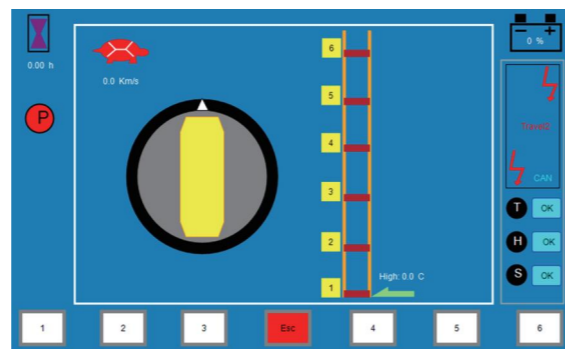

■ One-key linkage of the fork* One-key return to the center

The optional side shift and rotation linkage action function can quickly adjust the direction of the fork by one-key operation in the ultra-narrow working aisle, which is convenient for fork to take the goods on both sides. The one-key return function of the fork is convenient for picking up the goods in the forward direction and reducing the labor intensity.

■ All-wheel electromagnetic braking* Extremely short braking distance

Vehicle driving wheel (rear wheel) and load-bearing wheel (front wheel), three sets of wheel trains are equipped with electromagnetic brake assembly as standard, multiple sets of braking systems work together to provide powerful braking force of the whole vehicle, ensuring braking under various working conditions. The system is stable and reliable, and fully guarantees the safety of operation.

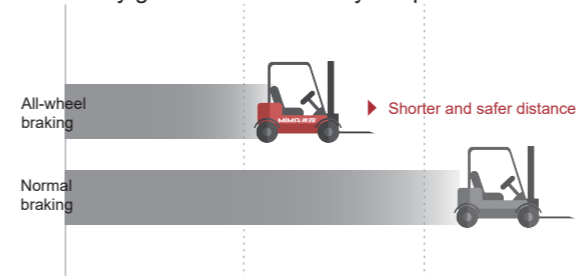

■ Automatic speed limit for turning

It has the function of turning speed limit, and automatically decelerates when turning, so as to protect the safety of people and goods and make driving more reassuring.

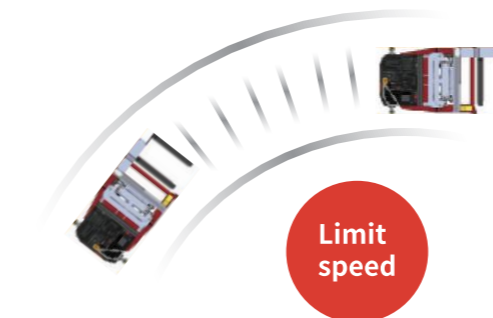

Configuration table

	MC10/16	MCA16	MCC16
Import Curtis controller	✓	✓	✓
Imported hydraulic components	✓	✓	✓
Fork Vision System	✓	✓	
Wheel display function	✓	✓	✓
Electronic steering	✓	✓	✓
High precision mast	✓	✓	✓
Mechanical guide	✓	✓	✓
Automatic speed limit for turning	✓	✓	✓
All wheel braking		✓	✓
Magnetic navigation mode	Optional	Optional	✓
One-key linkage of fork / one-key return to center	Optional	✓	✓
Electric fork head	Optional	✓	✓ <small>(Electro-hydraulic safety fork)</small>
Height pre selection	Optional	Optional	✓
Reverse video			✓
Two-hand induction OPS system			✓
Full -Ac System Maintenance free system	48V	48V	80V

* please refer to the configuration table for some model options

MCC16 Man-up Turret Truck

Excellent view, Safe and Efficient, High-level Picking

The operator goes up with the platform
 The operator feels less vibration when up and down.
 Spacious, draught-protected cab, with good visibility.
 Make work easier.

Front mounted sub-mast
 More space for operator picking
 Better vision
 Safer

Fork flexible operation
 One-key linkage
 Automated fork cycle
 Height pre-selection
 Simplify operation steps
 Improve working efficiency

Ergonomic control panel
 Position can be adjusted, work comfortably while sitting or standing.
 The color display on the control panel shows all the important information, such as time, speed, lift height and steering angle.
 Physical buttons, prevent incorrect operation.

Folding seat
 The operator can adjust the height and angle of the folding seat

Numerous Modes of Operation

Integrates various functions to enable the operator to perform optimally and improve work efficiency

The main mast can be lifted and lowered while the vehicle is running

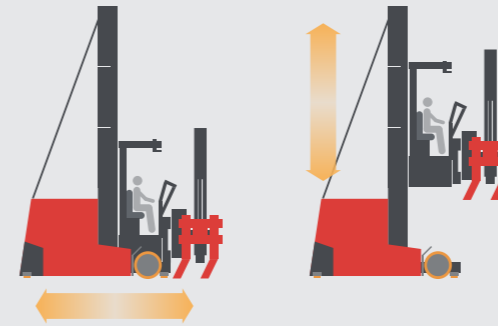

Main mast and auxiliary mast can be lifted and lowered at the same time

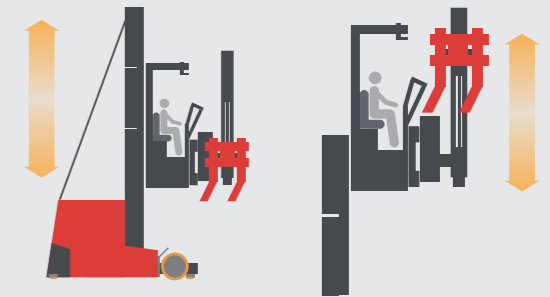

The fork can be rotated while doing side shift

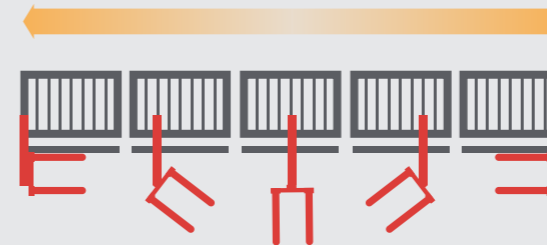

Stacking + Picking
 One equals two (stacker+order picker)

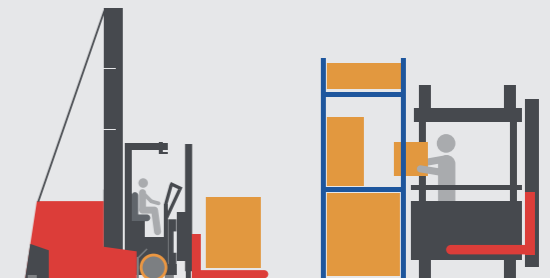

Applications



Standard					
1.1	Manufacturer	MiMA	MiMA	MiMA	
1.2	Model	MC 10	MC 10SQ	MC16SQ	
1.3	Power type	Battery	Battery	Battery	
1.4	Driving style	Stand on	Stand on	Stand on	
1.5	Rated load	Q(kg)	1000	1000	1600
1.6	Load center	C(mm)	500	500	600
1.7	Axle load	x(mm)	657	657	666
1.8	Wheelbase	y(mm)	1605	1605	1700
Weight					
2.1	Service weight(incl.battery)	kg	4235	4775	5660
Wheel					
3.1	Wheel type		PU	PU	PU
3.2	Load wheel size	mm	φ140×100	φ140×100	φ140×127
3.3	Drive wheel size	mm	φ380×165	φ380×165	φ380×165
3.4	Auxiliary wheel size	mm	φ204×76	φ204×76	φ204×76
3.5	Number of wheels,front/rear(x=drive wheel)		4 /1x+2	4 /1x+2	4 /1x+2
3.6	Wheel tread,drive side	b10(mm)	726	726	726
3.7	Wheel tread,load side	b11(mm)	1210	1210	1280
4.1	Mast closed height	h1(mm)	2415	2640	2765
4.2	Free lift height	h2(mm)	0	1750	1750
4.3	Lift height	h3(mm)	3000	4500	4500
4.4	Mast extended height with load backrest	h4(mm)	3915	5424	5570
4.5	Overhead guard height	h6(mm)	2260/2300	2260/2300	2260/2300
4.6	Stand on height	h7(mm)	355	355	355
4.7	Overall length	l1(mm)	2906	2906 ^[1]	3020
4.8	Overall width	b1(mm)	1450	1450	1575[1]
4.9	Fork size	l/e/s(mm)	1000/125/50	1000/125/50	1200/125/50
4.10	Installation level		II A	II A	II A
4.11	Fork outside width	b5(mm)	265~760	265~760	265~765
4.12	Min.ground clearance	m1(mm)	40	40	60
4.13	Aisle width for pallet 1000x1000mm	Ast(mm)	1500	1500 ^[2]	1600[2]
4.14	Turning radius	Wa(mm)	1880	1880 ^[1]	1980
4.15	Main Aisle width for pallet 1200x1200mm	mm	≥3700	≥3700	≥(3450+350)[3]
Function					
5.1	Driving speed (load/unloaded)	km/h	7.5/8	7.5/8	7.5/8
5.2	Lifting speed (load/unloaded)	mm/s	260/300	260/300	260/300
5.3	Lowering speed (load/unloaded)	mm/s	310/310	310/310	360/390
5.4	Braking method		Mechanical	Mechanical	Regenerative Braking, Electromagnetic Braking
Drive					
6.1	Drive motor power (S2-60min)	kw	5.5 AC	5.5 AC	5.5 AC
6.2	Lift motor power (S3-15%)	kw	12.8 AC	12.8 AC	15 AC
6.3	Lead acid battery, voltage/capacity	V/Ah	48/390	48/390 ^[2]	48/480[4]
6.4	Battery weight	kg	650	650	765
6.5	Steering system		Electric power steering	Electric power steering	Electric power steering
Other					
7.1	Battery replacement method		Side pull	Side pull	Side pull

Notice: [1] : Optional models with standard magnetic navigation function, stacking aisle width 1550mm, turning radius 1950mm, whole length 2976mm.[2] : Optional lithium battery specification 48V/300Ah.[3] : Select the standard electric fork model , and the width of stacking aisle is 1500mm

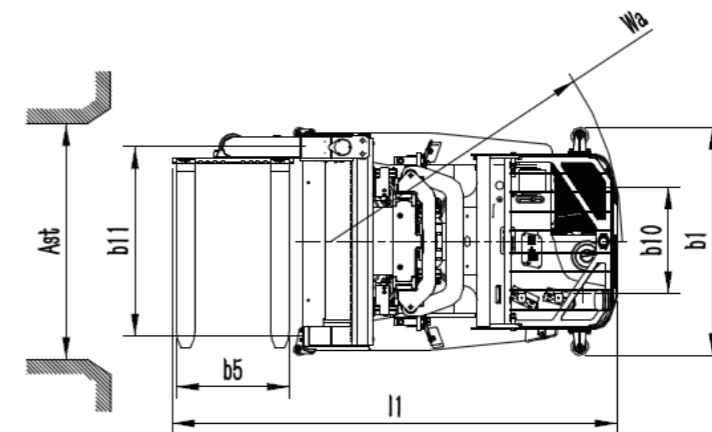
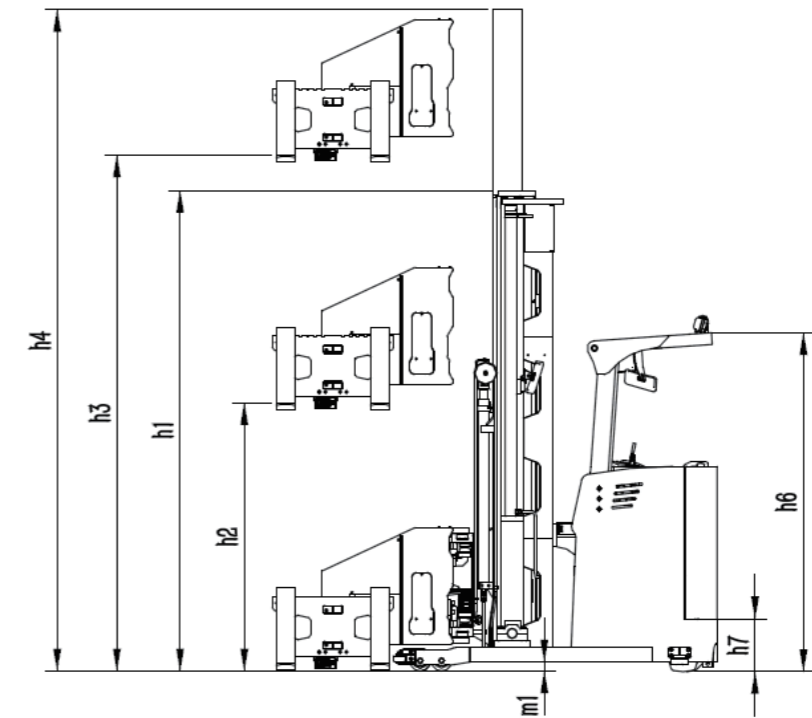

Standard		
1.1	Manufacturer	MiMA
1.2	Model	MCA16SQ
1.3	Power type	Battery
1.4	Driving style	Stand on
1.5	Rated load	Q(kg) 1600
1.6	Load center	C(mm) 600
1.7	Axle load	x(mm) 860
1.8	Wheelbase	y(mm) 1800
Weight		
2.1	Service weight(incl.battery)	kg 6000
Wheel		
3.1	Wheel type	PU
3.2	Load wheel size	mm $\phi 343 \times 150$
3.3	Drive wheel size	mm $\phi 400 \times 160$
3.4	Number of wheels,front/rear(x=drive wheel)	2 / 1X
3.5	Wheel tread,load side	b11(mm) 1315
Size		
4.1	Mast closed height	h1(mm) 2765
4.2	Free lift height	h2(mm) 1670
4.3	Lift height	h3(mm) 4500
4.4	Mast extended height with load backrest	h4(mm) 5650
4.5	Overhead guard height	h6(mm) 2250
4.6	Stand on height	h7(mm) 600
4.7	Overall length	l1(mm) 3330
4.8	Overall width	b1(mm) 1575[1]
4.9	Fork size	l/e/s(mm) 1200/125/50
4.10	Installation level	II B
4.11	Fork outside width	b5(mm) 265~765
4.12	Min.ground clearance	m1(mm) 80
4.13	Aisle width for pallet 1000x1000mm	Ast(mm) 1600[2]
4.14	Turning radius	Wa(mm) 2080
4.15	Main Aisle width for pallet 1200x1200mm	mm $\geq (3900+400)$ [3]
Function		
5.1	Driving speed (load/unloaded)	km/h 8/8
5.2	Lifting speed (load/unloaded)	mm/s 300/300
5.3	Lowering speed (load/unloaded)	mm/s 340/340
5.4	Max. gradeability(unload)	8%
5.5	Driving brake method	Regenerative Braking, Electromagnetic Braking
5.6	Parking brake method	Electromagnetic brake
Drive		
6.1	Drive motor power (S2-60min)	kw AC
6.2	Lift motor power (S3-15%)	kw AC15
6.3	Lead acid battery, voltage/capacity	V/Ah 48/600[4]
6.4	Battery weight	kg 945
6.5	Steering system	Electric power steering
Other		
7.1	Battery replacement method	Side pull

Notice: [1]: The width of the vehicle without the guide wheels is 1470mm; [2]: The vehicle equipped with magnetic navigation function, the stacking aisle width is 1650mm; [3]: The main aisle width safety margin +350mm; [4]: Specifications of optional car battery: 48V/300Ah.

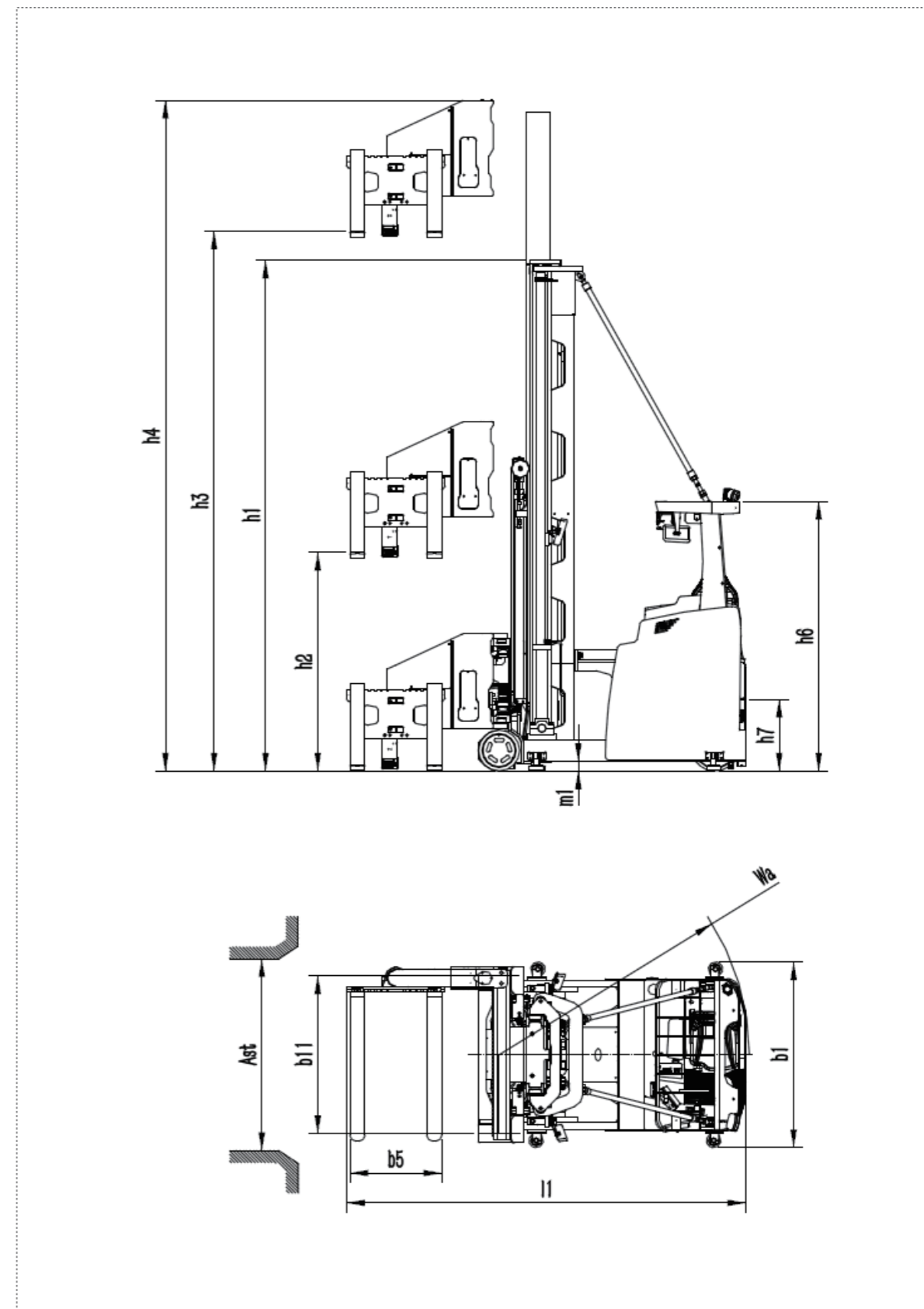

Standard		
1.1	Manufacturer	MiMA
1.2	Model	MCC16
1.3	Power type	Battery
1.4	Driving style	Stand/seat (man-up)
1.5	Rated load	Q(kg) 1600
1.6	Load center	C(mm) 600
1.7	Axle load	x(mm) 435
1.8	Wheelbase	y(mm) 1950
Weight		
2.1	Service weight(incl.battery)	kg 7720
Wheel		
3.1	Wheel type	PU
3.2	Load wheel size	mm $\phi 380 \times 192$
3.3	Drive wheel size	mm $\phi 400 \times 160$
3.4	Number of wheels,front/rear(x=drive wheel)	2 / 1X
3.5	Wheel tread,load side	b11(mm) 1310
Size		
4.1	Mast closed height	h1(mm) 3665
4.2	Free lift height	h2(mm) /
4.3	Lift height of Main mast	h3(mm) 4500
4.4	Mast extended height	h4(mm) 7130
4.5	Overhead guard height	h6(mm) 2590
4.6	Stand board height	h7(mm) 445
4.7	Auxiliary lifting height	h9(mm) 1700
4.8	Lift height of the station board from the ground	h12(mm) 4945
4.9	Total lift height	h3+h9(mm) 6200
4.10	Max. picking height	h12+1600(mm) 6545
4.11	Overall length(Forks 90°)	l1(mm) 3690
4.12	Overall length(Forks 0°, to the vertical surface of the forks)	l2(mm) 3475
4.13	Overall width	b1/ b2(mm) 1244/1502
4.14	Fork size	l/e/s(mm) 1200/125/50
4.15	Installation level	II B
4.16	Fork outside width	b5(mm) 260~725
4.17	Side shift distance	mm 1300
4.18	Distance between fork rotation center and front axle center	l8(mm) 1095
4.19	Outer distance of guide wheel	b6(mm) 1550
4.20	Minimum ground clearance of mast	m1(mm) 45
4.21	Minimum ground clearance of body wheelbase center	m2(mm) 80
4.22	Turning radius	Wa(mm) 2235
4.23	Aisle width for pallet 1200×1200	Ast(mm) 1650[1]
4.24	Main aisle width	mm $\geq (4100+900)$ [2]
Function		
5.1	Driving speed (load/unloaded)	km/h 10/10
5.2	Lifting speed (load/unloaded)	mm/s 320/320
5.3	Lowering speed (load/unloaded)	mm/s 400/380
5.4	Maximum climbing ability, load/unloaded (S2-5min)	%(tan θ) 5/8
5.5	Driving brake type	Regenerative brake/hydraulic brake
5.6	Parking brake type	Electromagnetic brake
Drive		
6.1	Drive motor power (S2-60min)	kw 8 AC
6.2	Lift motor power (S3-15%)	kw 21 AC
6.3	Lead acid battery, voltage/capacity	V/Ah 80/560[3]
6.4	Battery weight	kg 1530
6.5	Steering system	Electric power steering
Other		
7.1	Battery replacement method	Side pull

Notice: [1]: The safety margin of the width of the main aisle of the magnetic guide model needs to be +900mm, and the mechanical guide model needs to be +400mm; [2]: Optional lithium battery specification: 80V/450Ah or 80V/600Ah [3]: Optional lead-acid battery Specifications: 80V/840Ah; [4]: Magnetic navigation function models, stacking net aisle width +50mm;

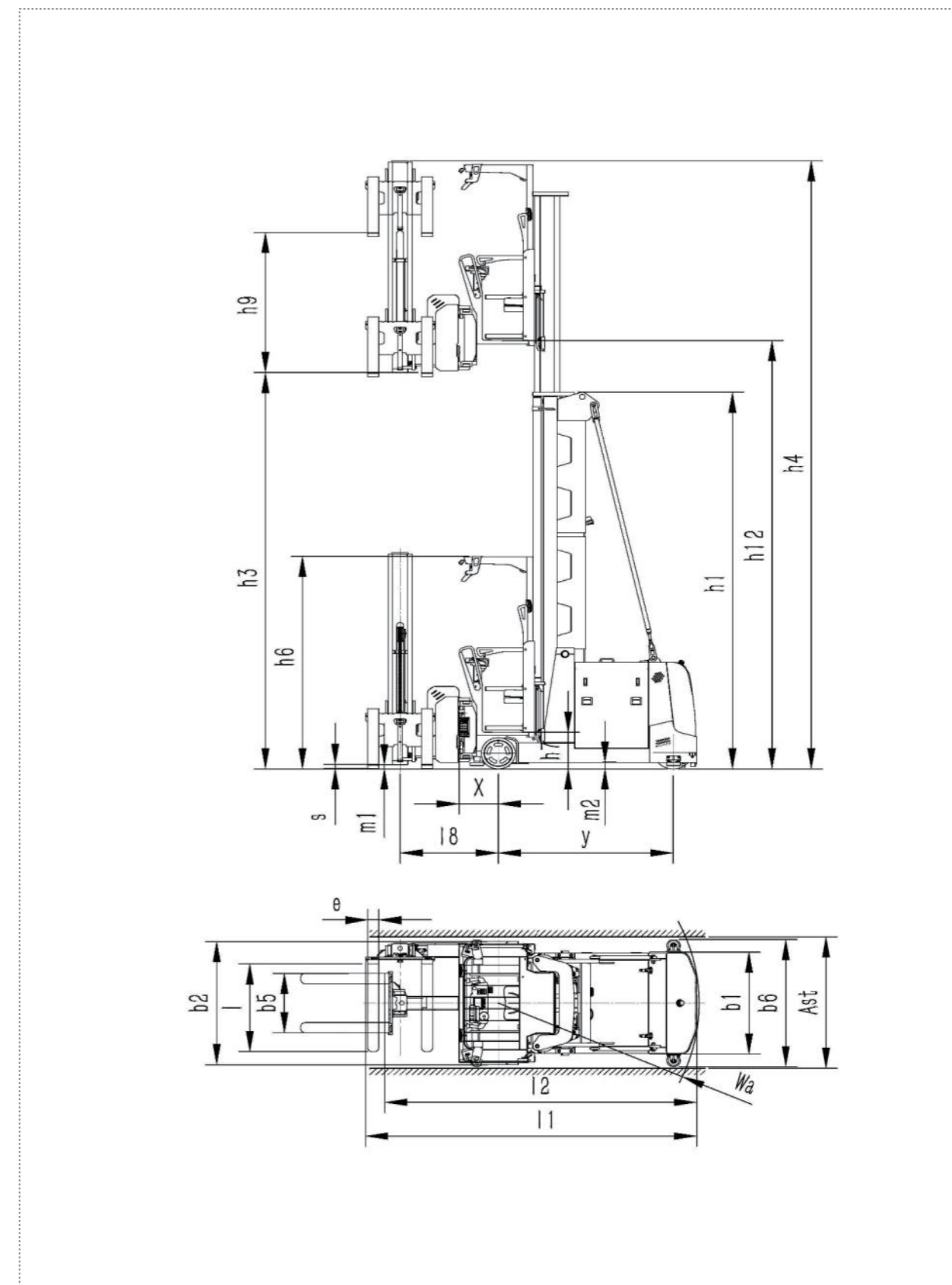

MC10 Mast specification

Duplex mast									
Model	MC	10-25	10-30	10-35	10-40	10-45	10-50	10-55	10-60
Lift height	h3(mm)	2500	3000	3500	4000	4500	5000	5500	6000
Height of mast, extended (with block)	h4(mm)	3415	3915	4415	4915	5415	5915	6415	6915
Height of mast, lowered	h1(mm)	2165	2415	2665	2915	3165	3415	3665	3915

Triplex full free mast									
Model	MC	10SQ-45	10SQ-50	10SQ-55	10SQ-60	10SQ-65	10SQ-70	10SQ-75	
Lift height	h3(mm)	4500	5000	5500	6000	6500	7000	7500	
Height of mast, extended (with block)	h4(mm)	5424	5924	6424	6924	7424	7924	8424	
Height of mast, lowered	h1(mm)	2640	2810	2975	3140	3310	3475	3640	
Free lift height	h2(mm)	1750	1910	2080	2250	2410	2580	2750	

MC16 Mast specification

Triplex full free mast													
Model	MC	16SQ-45	16SQ-50	16SQ-55	16SQ-60	16SQ-65	16SQ-70	16SQ-75	16SQ-80	16SQ-85	16SQ-90	16SQ-95	16SQ-100
Lift height	h3(mm)	4500	5000	5500	6000	6500	7000	7500	8000	8500	9000	9500	10000
Height of mast, extended (with block)	h4(mm)	5570	6070	6570	7070	7570	8070	8570	9070	9570	10070	10570	11070
Height of mast, lowered	h1(mm)	2765	2935	3100	3265	3435	3600	3765	3935	4100	4265	4435	4600
Free lift height	h2(mm)	1750	1910	2080	2250	2410	2580	2750	2910	3080	3250	3410	3580

MCA16 Mast specification

Triplex full free mast																	
Model	MCA	16SQ-45	16SQ-50	16SQ-55	16SQ-60	16SQ-65	16SQ-70	16SQ-75	16SQ-80	16SQ-85	16SQ-90	16SQ-95	16SQ-100	16SQ-105	16SQ-110	16SQ-115	16SQ-120
Lift height	h3(mm)	4500	5000	5500	6000	6500	7000	7500	8000	8500	9000	9500	10000	10500	11000	11500	12000
Height of mast, extended (with block)	h4(mm)	5650	6150	6650	7150	7650	8150	8650	9150	9650	10150	10650	11150	11650	12150	12650	13150
Height of mast, lowered	h1(mm)	2765	2935	3100	3265	3435	3600	3765	3935	4100	4265	4435	4600	4765	4935	5100	5265
Free lift height	h2(mm)	1670	1830	2000	2170	2330	2500	2670	2830	3000	3170	3330	3500	3670	3830	4000	4170

MCC16 Mast specification

Duplex mast												
Model	MCC	16-45	16-50	16-55	16-60	16-65	16-70	16-75	16-80	16-85	16-90	16-95
Main mast lifting height	h3(mm)	4500	5000	5500	6000	6500	7000	7500	8000	8500	9000	9500
Total lifting height	h3+h9(mm)	6200	6700	7200	7700	8200	8700	9200	9700	10200	10700	11200
Mast extended height	h4(mm)	7130	7630	8130	8630	9130	9630	10130	10630	11130	11630	12130
Mast closed height	h1(mm)	3665	3915	4165	4415	4665	4915	5165	5415	5665	5915	6165
Max. picking height	h12+1600(mm)	6545	7045	7545	8045	8545	9045	9545	10045	10545	11045	11545

The dimension of rack and aisle

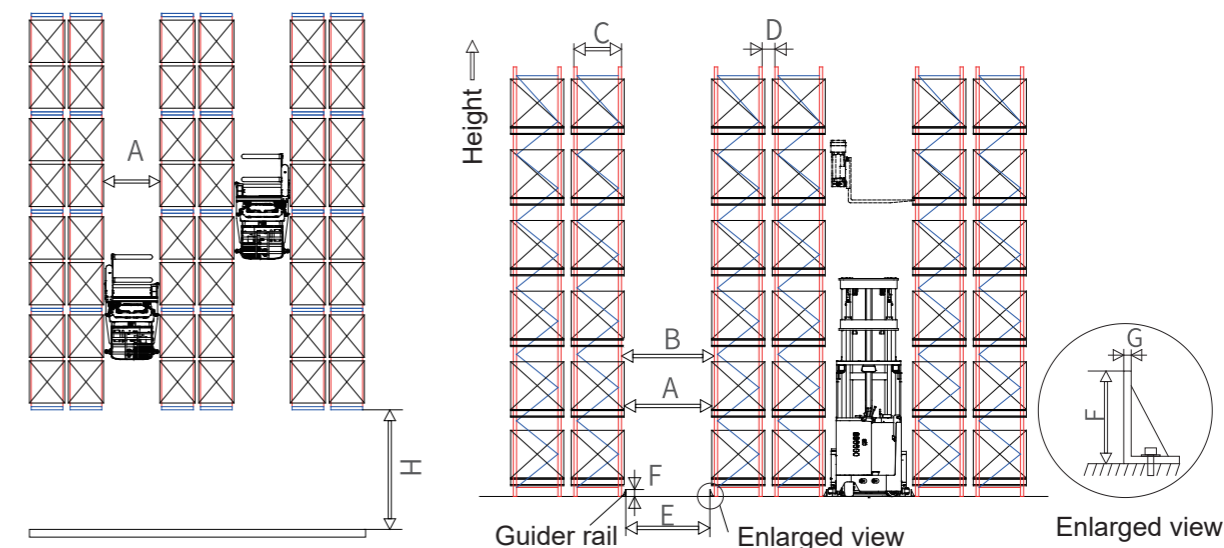

Dimension Sheet

Mode	MC10			MC16			MCA16			MCC16		
Pallet size	1000×1000 1000×1200	1100×1100	1200×1200 1000×1200	1000×1000 1000×1200	1100×1100	1200×1200 1000×1200	1000×1000 1000×1200	1100×1100	1200×1200 1000×1200	1000×1000 1000×1200	1100×1100	1200×1200 1000×1200
Load center	C500	C550	C600	C500	C550	C600	C500	C550	C600	C500	C550	C600
Fork length	1000	1070	1200	1000	1100	1200	1000	1100	1200	1000	1100	1200
A Net width of aisle/goods to goods	1500/1550 ⁽¹⁾	1500/1550 ⁽¹⁾	1600/1650 ⁽¹⁾	1600/1650 ⁽¹⁾			1600/1650 ⁽¹⁾			1650		
B The beam spacing between the rack	1700/1750 ⁽¹⁾	1700/1750 ⁽¹⁾	1800/1850 ⁽¹⁾	1800/1850 ⁽¹⁾			1800/1850 ⁽¹⁾			1850		
C Net deeps of rack	800	900	1000	800	900	1000	800	900	1000	800	900	1000
D Rack spacing	≥300			≥300			≥300			≥300		
H Main aisle width	≥3700		≥3800	≥3800			4300/4800 ⁽¹⁾			4500/5000 ⁽¹⁾		
E Inner side of the rail	1480±5			1580±5			1580±5			1580±5		
F Rail height	≥100			≥100			≥100			≥100		
G Rail thickness	≥8			≥10			≥10			≥10		

Remarks: (1) Tail mark is the net aisle size of the rack in magnetic navigation mode:
 ■ This mark is the net aisle size of the rack with optional electric fork head.
 The above dimensions are corresponding to standard models and standard working conditions.
 If you have special size requirements, please contact our sales manager to obtain customized design.

CUSTOMER CASE



COMPANY INTRODUCTION

Hefei Banyitong Technology Development Co., Ltd., founded in 1994, is a high-tech enterprise specializing in the design and manufacture of electric storage forklifts and customized logistics equipment. Our company has won the People's Republic of China special equipment production license, ISO9001:2008, CE certification and so on.

With more than 20 years of continuous improvement, MIMA brand is based on the company's strong scientific research and innovation team, with the design concept of "safety, durability, comfort, low carbon (environmental protection)", to provide customers with 500KG-100T application solutions, storage equipment and related services. Through continuous technological innovation and accumulation of patents, our products have involved more than 50 varieties in 12 categories, such as electric pallet trucks, pallet stackers, reach trucks, counterbalanced forklifts, tow tractor, low-level and high-level order picker, VNA three-way forklifts, four-way and multi-directional forklifts, AGV forklift, unmanned aisle stackers and customized logistics equipment. MIMA brand products are widely used in medicine, food, chemical, electronics, machinery, furniture, logistics and other industries.

In order to serve users better and more comprehensively, our company has established a sales and service system that integrates consulting, planning and design, and comprehensive services. Now we have established offices directly

under the company and 68 agents and distribution service providers across the country. And set up professional sales service network and dealers in more than 60 overseas countries and regions. The broad marketing network and perfect pre-sale, in-sale and after-sale service system ensure that you can get the machine and the service from us.

MIMA promise of "Even if there is only one piece of equipment in the world, we will custom made it for you" has always been a work guide for employees. After more than 20 years of struggle, we have successfully provided various customized forklift logistics equipment solutions to various customers in different industries, which have been highly praised and recognized by our customers.

"Safety, quality, innovation, service" has been the consistent business philosophy of MIMA brand for more than 20 years. The industry prospect of "Min spac. And Max performance" is the driving force for the unremitting efforts and hard work of all MIMA employees. In the future, MIMA will stand in the east of the world with a more proud posture, and present it to customers with a more excellent design concept and comprehensive service system, so that customers can cooperate once and become friends for life!

